

Mecca Care 25mm Grab Rail 300/450/600/900/1200mm

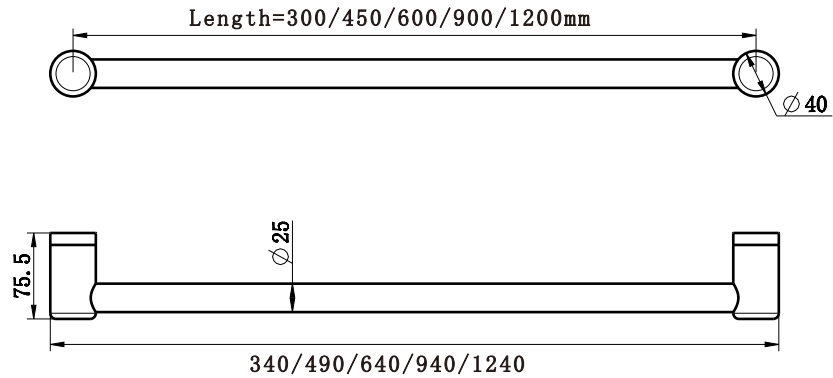

Available Colour



CHROME



MATTE BLACK



BRUSHED NICKEL



GUN METAL



BRUSHED GOLD



BRUSHED BRONZE

SKU

300MM LENGTH

NR CR2512CH/NR CR2512MB/NR CR2512BN/NR CR2512BG
NR CR2512GM/NR CR2512BZ

450MM LENGTH

NR CR2518CH/NR CR2518MB/NR CR2518BN/NR CR2518BG
NR CR2518GM/NR CR2518BZ

600MM LENGTH

NR CR2524CH/NR CR2524MB/NR CR2524BN/NR CR2524BG
NR CR2524GM/NR CR2524BZ

900MM LENGTH

NR CR2530CH/NR CR2530MB/NR CR2530BN/NR CR2530BG
NR CR2530GM/NR CR2530BZ

1200MM LENGTH

NR CR2548CH/NR CR2548MB/NR CR2548BN/NR CR2548BG
NR CR2548GM/NR CR2548BZ



Features

1. Australian owned and designed.
2. Sizes: 300 -1200mm lengths as standard.
3. Modular design, the rail to be mounted horizontally, vertically or at any angle and cut down to suit your bathroom.
4. 150kg capacity for all 25mm and 32mm diameter grab rails.
5. 25mm diameter rails are suitable for heavy duty towel rails and smaller.
6. Gun metal, brushed gold and brushed bronze colours are PVD coated for long term durability.

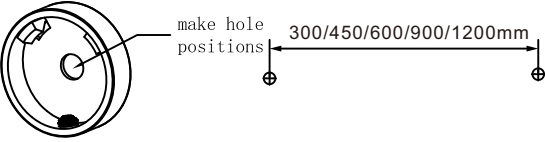
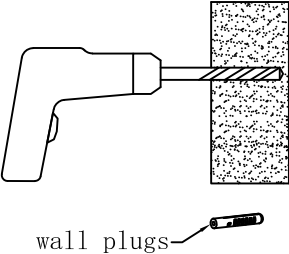
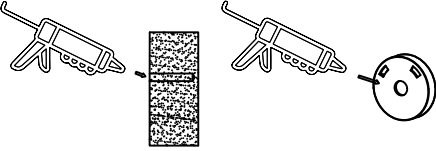

MECCA CARE
ASSISTED LIVING 25MM

Installation Instruction

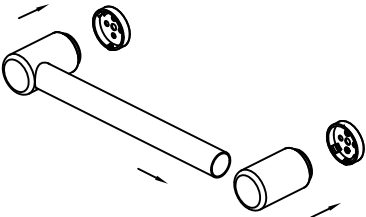
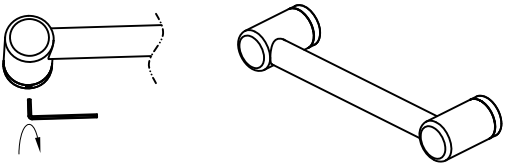
	<p>1. Locate wall studs, install into at least one stud. Place wall seal/mounting bracket on wall at correct height over centre of stud and mark hole positions on wall.</p>
	<p>2. Drill pilot holes into wall stud approximately 60mm deep to suit mounting screws (and wall plugs if required).</p> <p>Tip: 4mm hole for screws into timber or 10mm hole for wall plugs.</p>
	<p>3. Apply small amount of silicon to mounting bracket and wall in and around the screw holes.</p>
	<p>4. Install mounting brackets by screwing onto wall.</p> <p>Tip: Use appropriate mounting screws for the wall stud material, supplied screws are for timber wall studs.</p>
	<p>5. Slide rail tube into end bracket and push onto wall brackets.</p> <p>Tip: Rail length can be cut down to a smaller size, simply use an angle grinder, hacksaw or pipe cutter then deburr the end with a file or grinder and reinsert into the end bracket.</p>
	<p>6. Tighten grub screws with Allen key.</p> <p>Tip: If rail rattles, loosen end bracket, twist slightly and tighten.</p>

WARNING:

These rails are designed to be mounted onto wall studs or masonry walls. Installation is recommended to be completed by qualified trades person who complies with the AS 1428.1-2009 design for access and mobility standard.

It is recommended rail location is determined by a qualified occupational therapist or trained professional to the AS 1428.1-2009 standard. Correct installation is required to ensure safe, long term operation. Incorrect mounting can result in reduced capacity of the rail which can result in injury to user and damage to the wall.